

1-Line Low Capacitance Bi-directional TVS Diode

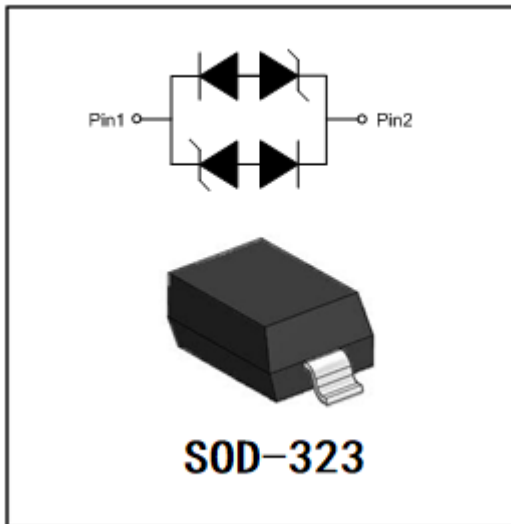

Features

- 340W peak pulse power (8/20 μ s)
- Ultra low capacitance: 1pF typical
- Ultra low leakage: nA level
- Operating voltage: 3.3V
- Low clamping voltage
- Protects one power line or data line
- Complies with following standards:
 - IEC 61000-4-2 (ESD) immunity test
 - Air discharge: ± 30 Kv
 - Contact discharge: ± 30 kV
 - IEC61000-4-5 (Lightning) 30A (8/20 μ s)
- RoHS Compliant

Marking Information



■ Maximum Ratings

PARAMETER	SYMBOL	VALUE	UNIT
Peak Pulse Power (8/20 μ s)	P _{pk}	340	W
Peak Pulse Current (8/20 μ s)	I _{pp}	21	A
ESD per IEC 61000-4-2 (Air) ESD per IEC 61000-4-2 (Contact)	V _{ESD}	± 30 ± 30	KV
Operating Temperature Range	T _J	-55 to +125	°C
Storage Temperature Range	T _{stg}	-55 to +150	°C



ESDSL3V3D3BA

■ Electrical Characteristics (T_a=25°C Unless otherwise specified)

PARAMETER	SYMBOL	UNIT	CONDITIONS	MIN	TYP	MAX
Reverse Working Voltage	V _{RWM}	V				3.3
Reverse breakdown voltage	V _{BR}	V	I _{BR} = 1mA	3.5		
Reverse Leakage Current	I _R	μA	V _{RWM} = 3.3V			0.2
Clamping Voltage	V _C	V	I _{PP} = 1A (8/20μs pulse)			7
Clamping Voltage	V _C	V	I _{PP} = 21A (8/20μs pulse)			16
Junction Capacitance	C _J	pF	V _R = 0V, f = 1MHz		1	1.5

■ Characteristics (Typical)

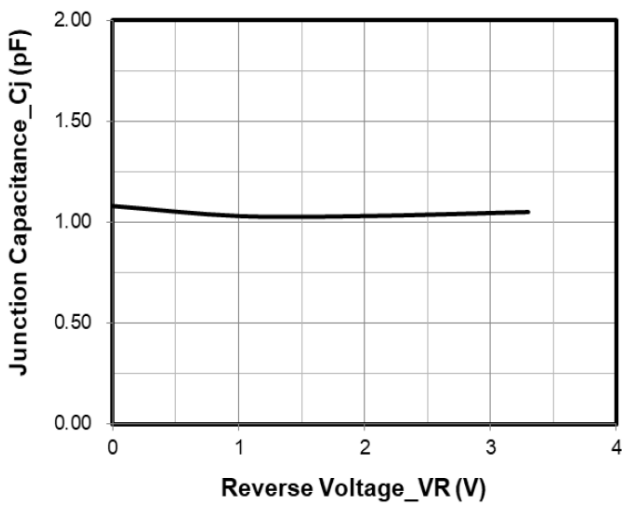

Junction Capacitance vs. Reverse Voltage

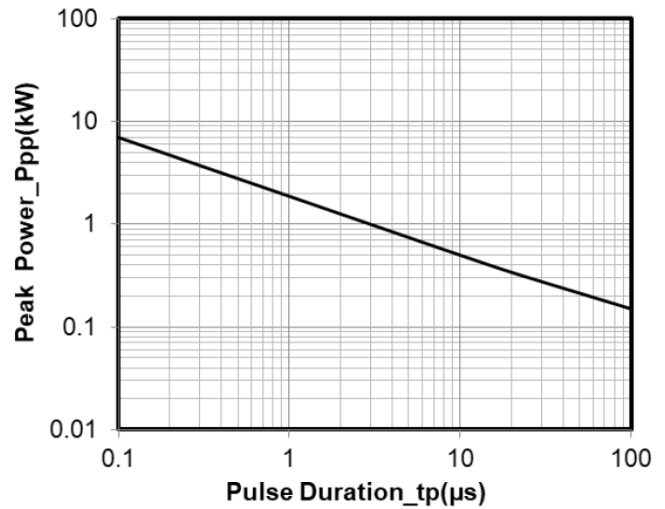

Peak Pulse Power vs. Pulse Time

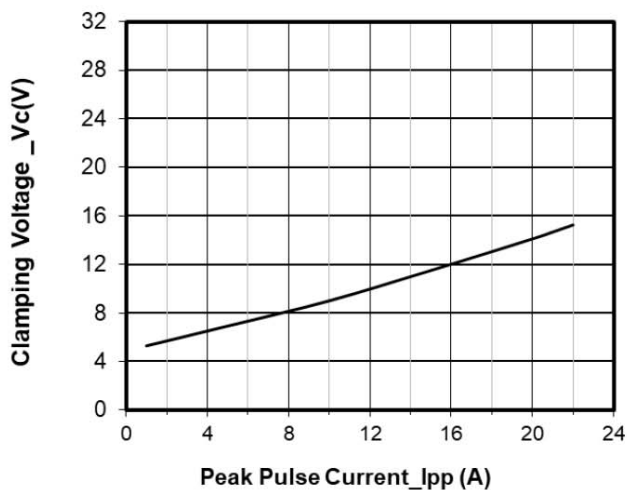

Clamping Voltage vs. Peak Pulse Current

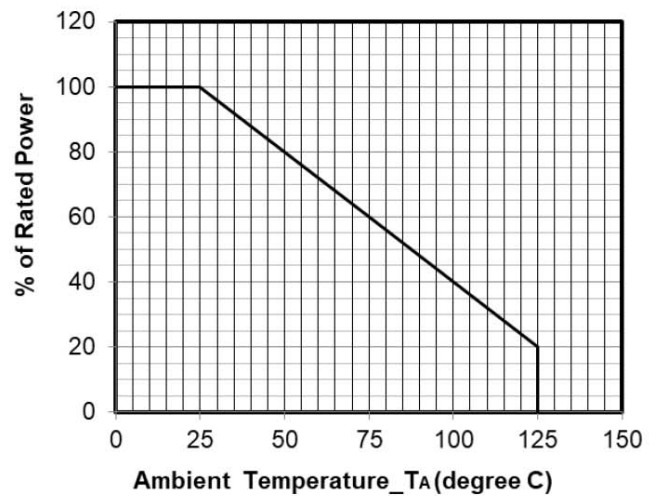

Power Derating Curve



ESDSL3V3D3BA

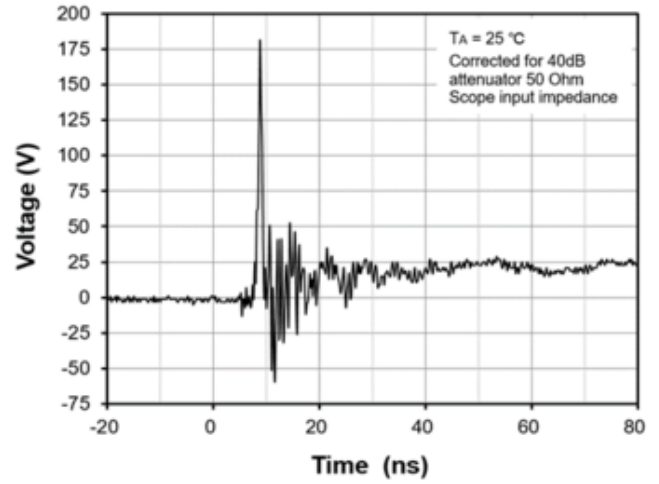
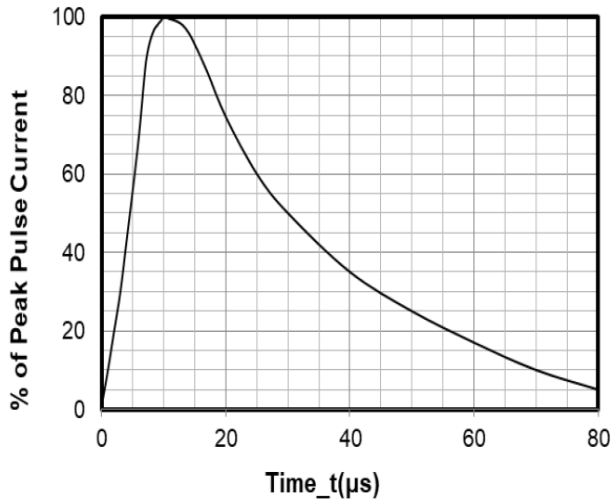

8 X 20μs Pulse Waveform

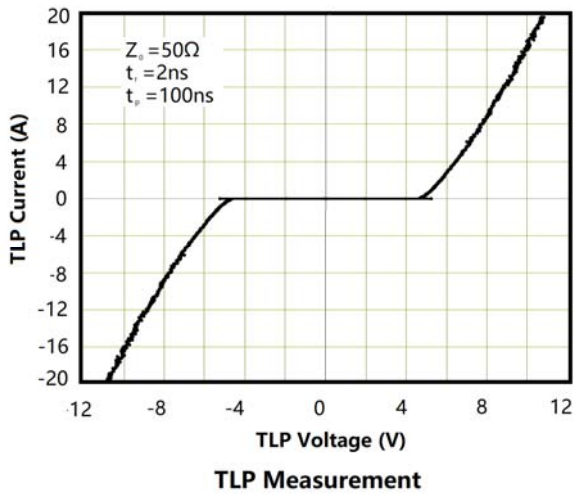

TLP Measurement



ESDSL3V3D3BA

■ Outline Dimensions

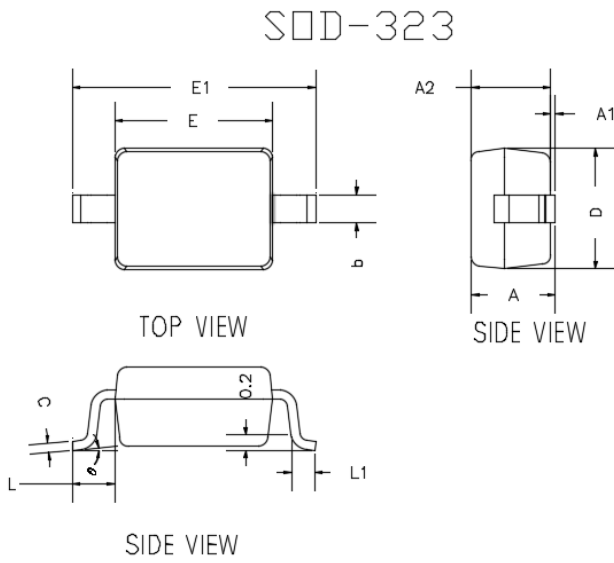

DIMENSIONS				
DIM	INCHES		MM	
	MIN	MAX	MIN	MAX
A	---	0.0393	---	1.0000
A1	0.0000	0.0039	0.0000	0.1000
A2	0.0314	0.0354	0.8000	0.9000
b	0.0098	0.0157	0.2500	0.4000
c	0.0031	0.0059	0.0800	0.1500
D	0.0472	0.0551	1.2000	1.4000
E	0.0629	0.0709	1.6000	1.8000
E1	0.0984	0.1063	2.5000	2.7000
L	0.0187TYP		0.475TYP	
L1	0.0098	0.0157	0.250	0.400
θ	0°	8°	0°	8°

■ Soldering Footprint

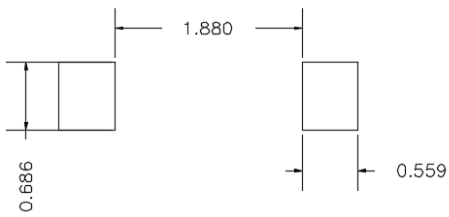

UNIT : mm

SUGGESTED SOLDER PAD LAYOUT



ESDSL3V3D3BA

Disclaimer

The information presented in this document is for reference only. Yangzhou Yangjie Electronic Technology Co., Ltd. reserves the right to make changes without notice for the specification of the products displayed herein to improve reliability, function or design or otherwise.

The product listed herein is designed to be used with ordinary electronic equipment or devices, and not designed to be used with equipment or devices which require high level of reliability and the malfunction of which would directly endanger human life (such as medical instruments, transportation equipment, aerospace machinery, nuclear-reactor controllers, fuel controllers and other safety devices), Yangjie or anyone on its behalf, assumes no responsibility or liability for any damages resulting from such improper use of sale.

This publication supersedes & replaces all information previously supplied. For additional information, please visit our website [http:// www.21yangjie.com](http://www.21yangjie.com) , or consult your nearest Yangjie's sales office for further assistance.